

Cabasse



Since 1950

THE PEARL COLLECTION
User guide



THE PEARL
THE PEARL AKOYA
THE PEARL SUB
THE PEARL PELEGRINA
THE PEARL KESHI

Thank you for purchasing a Cabasse speaker. We recommend you read this leaflet carefully to take full advantage of the speaker.

SAFETY INSTRUCTIONS

Explanation of symbols

Lightning within an equilateral triangle warns of the existence of dangerous, un-insulated high voltage inside the product enclosure, of sufficient value to present a risk of electric shock.

The exclamation point in an equilateral triangle warns of the existence of instructions usage and maintenance in the documentation attached to this product.

Cleaning - Unplug the unit before cleaning. Do not use cleaning solutions in liquid or aerosol form. Use preferably a damp cloth.

Installation on furniture and stands - Do not place this unit on an unstable stand, such as stands, tripods, tables, shelves, etc. It could fall and cause serious injury to a child or adult who is nearby.

Ventilation - The appliance must be positioned so that it does not interfere with its own ventilation. For example, it should not be installed on a bed, sofa, blanket or similar surfaces that could block its vents. It should not be embedded in confined spaces such as narrow shelves or furniture that could limit the amount of air available to the air intakes.

Power supply - The appliance must only be connected to a power source of the type written in the user manual or in line with the product. If you are unsure of the type of power supplied to your location, contact your dealer or the local power company.

Electrical Overloads - Do not overload power outlets, extension cords, or power reminders. This could result in fire or electrocution.

Foreign bodies and liquids - Care should be taken never to let foreign objects or liquids enter the unit. They could cause fires or electrocutions. Never pour liquid of any kind into the device.

Maintenance - - In the following cases, you must unplug your appliance and have it checked by a qualified technician:

the power supply or plug has been damaged.
foreign bodies or liquid have entered the device.

the unit has been exposed to rain or has been sprayed with water.

the unit does not seem to be working properly while you are using it as part of its normal operating instructions.

Only handle the controls covered by the user manual. Any other procedure could damage it and require the intervention of a qualified technician.

the unit has fallen or its bodywork is damaged.

the device shows significantly changed performance.

In a disturbed area environment (thunderstorm etc ...), the product may sometimes require shutdown and restart by means of the ON / OFF power switch located on the rear panel of the device to work properly again.

Spare parts - If the repair required the use of spare parts, make sure that the technician has used the references recommended by the manufacturer or having the same characteristics as the original parts. Non-conforming parts may cause fire, electric shock or other.

Checks - After any work on the unit, have the technician perform tests to ensure that the unit operates safely.

Plastic Bags -Do not leave plastic bags in the box within reach of children to avoid choking.

IMPORTANT SAFETY INSTRUCTIONS!

1. READ these instructions.
2. SAVE these instructions.
3. RESPECT all warnings.
4. FOLLOW all instructions.
5. DO NOT use this unit near water.
6. CLEAN ONLY with a dry cloth.
7. DO NOT obstruct the ventilation holes.
Install according to the manufacturer's instructions.
8. DO NOT install near any heat sources such as radiators, heat registers, stoves, or other apparatus (including amplifiers) that produce heat.
9. DO NOT disable the safety feature of the polarized or ground pin plug. A polarized plug has one blade wider than the other. A ground pin plug has two blades and a third pin for the ground. The wide blade or the third pin is provided for the safety of the user. If the provided plug does not fit into the outlet, have an electrician replace this outlet type that is too old.
10. PROTECT the power cord, making sure that it is not likely to be stomped or crushed, particularly near the

plugs, power strips and its point of exit from the device.

11. USE ONLY the accessories recommended by the manufacturer.
12. Unplug this apparatus during lightning storms or when unused for a long time.
13. CONFIRM any troubleshooting work to a competent professional repairer.

Have the device repaired in case of damage, for example: damaged plug or power cord, liquid spilled on the device or object inserted in the device, unit exposed to rain or moisture, malfunction or after a fall.

14. RUNOFF / HUMIDITY: To prevent fire or shock hazard, do not expose the unit to water or moisture. The appliance must not be exposed to any risk of liquid leaks, no object such as a vase will be placed on or above the appliance.
15. KEEP this product a safe distance away from any naked flame, such as a lit candle.
16. THE MAINS are nor disconnected in the off position, but the circuits are de-powered.



WARNING

THIS PRODUCT CONTAINS A BUTTON BATTERY

If swallowed, a lithium button battery can cause severe or fatal injuries within 2 hours.

Keep batteries out of reach of children.

If you think batteries may have been swallowed or placed inside any part of the body, seek immediate medical attention.



CAUTION: do not ingest the battery, fatal risk of chemical burn within 2 hours. Always keep button cells, new and used, out of reach of children. Seek immediate medical attention if you think that batteries may have been swallowed or inserted anywhere in the body. If the battery compartment no longer closes securely, stop using the product and keep it away from children.

UNPACKING

Open the cardboard box widely and take out the different elements one by one. If any of the items on the carton appear to be damaged, do not use it, put it back in the original carton and contact your dealer immediately.

Keep your packaging for possible future transport of your system.

THE COMPONENTS OF YOUR SYSTEM

THE PEARL

1 power cord, 1 remote control, 1 simplified instruction and 1 warranty card.

THE PEARL SUB

1 power cord, 1 remote control, 1 simplified instruction and 1 warranty card.

THE PEARL AKOYA

1 power cord, 1 remote control, 1 simplified instruction and 1 warranty card, 1 USB adaptor, 1 RCA-Jack 3.5 mm adapter , 1 carry bag.

THE PEARL KESHI

1 power cord, 1 remote control, 1 simplified instruction and 1 warranty card, 1 USB adaptor, 1 RCA-Jack 3.5 mm adapter , 1 wooden case, 2 wall brackets.

THE PEARL PELEGRINA

1 power cord, 1 remote control, 1 Cabasse book, 1 simplified manual and 1 warranty card.

REMOTE CONTROL KEYS THE PEARL

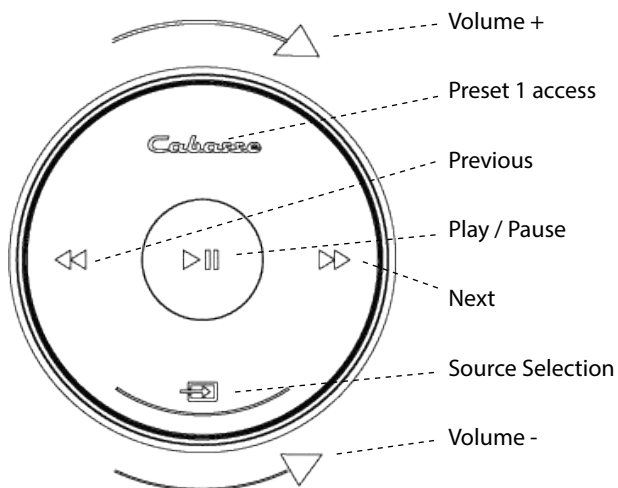

FUNCTIONS

	Bluetooth connection	WLAN/LAN via internet router / box
Loss less audio broadcast		YES
Access to all audio media from the WIFI network (computer ...)		YES
Multi-room		YES
Broadcast smartphone / tablet audio content	YES	YES
Broadcast audio application (youtube ...) from smartphone / tablet	YES	
Broadcasting from USB media		YES
Internet radio and music services		Qobuz, Deezer, Napster, Spotify, Tidal, Vtuner

THE PEARL

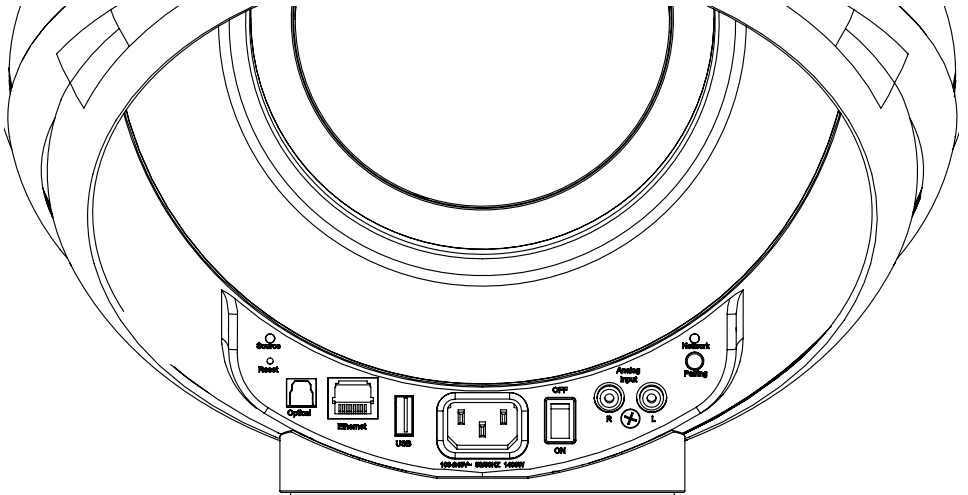

Status LED

Reset

Optical LAN USB

POWER

Pairing LED

Pairing

ON/OFF Analog RCA IN

THE PEARL ΛΚΟΥΛΑ

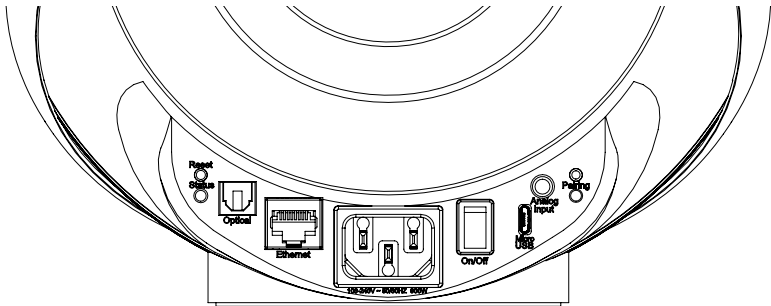

Reset
Status

Optical LAN

ON/OFF

POWER

Pairing LED
Pairing
Analog
Micro USB

THE PEARL SUB

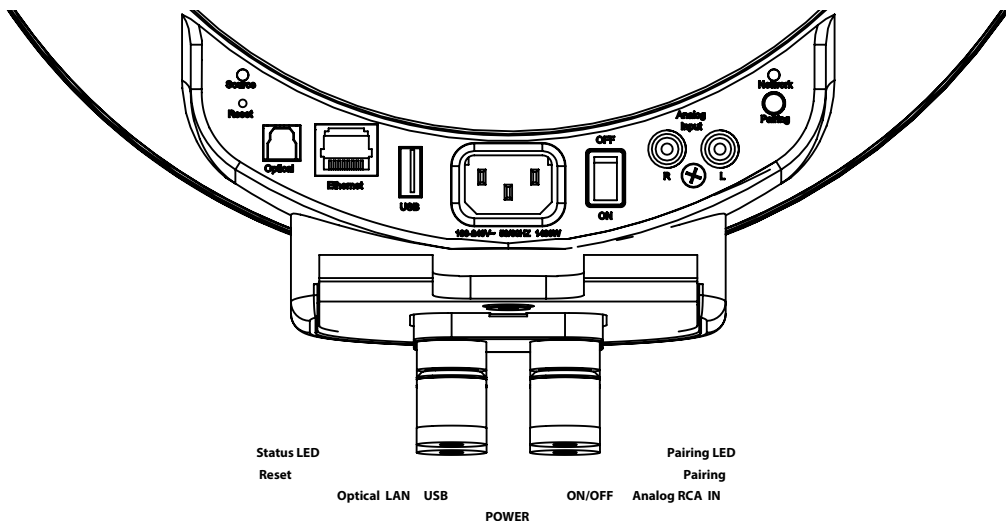

THE PEARL KESHI

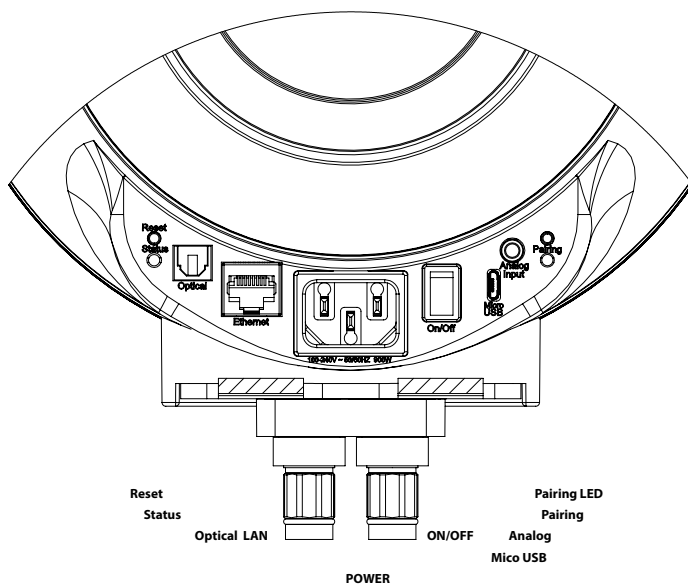

THE PEARL PELEGRINA

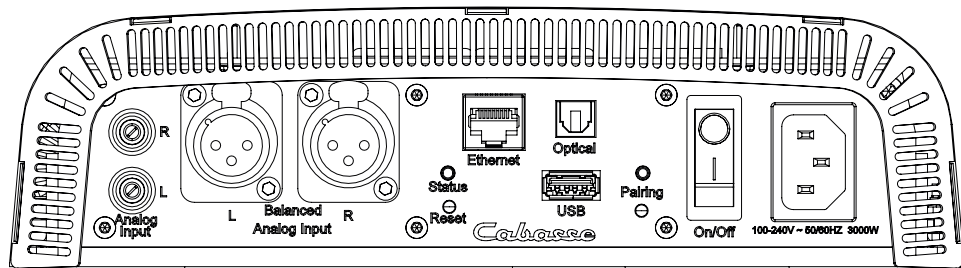

REMOTE CONTROL ACTIVATION

Before first use, unscrew the screw (PH00 screwdriver), remove the cover, remove the protective tab, replace the cover and retighten the screw.

The blue LED on the remote control flashes, waiting for pairing.

PAIRING THE REMOTE CONTROL

- 1- Connect the speaker to the mains.
- 2- Switch on the speaker using the on / off button on the back.
- 3- Press the "pairing" button on the back of THE PEARL/ THE PEARL AKOYA / THE PEARL SUB briefly. The LED "pairing" flashes.
- 4- The LEDs on the remote control and THE PEARL stop flashing when the pairing is finalized.

Replacement of the CR-2450 type button-cell: turn the remote control over, unscrew the screw, remove the cover, remove the old battery, insert the new battery, marked "+", to the outside, replace the cover, tighten the screw.

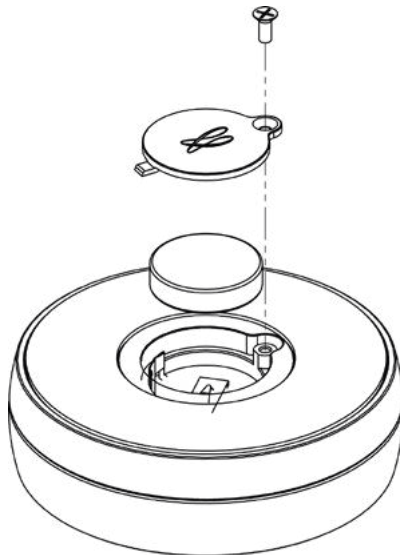

FIRST USE

Connect THE PEARL THE PEARL AKOYA/THE PEARL SUB to the mains with the proper power cord.

THE PEARL / THE PEARL AKOYA / THE PEARL SUB are operational as soon as the LED on the left of the rear panel opposite is lit in solid blue.

A voice announcement, if the volume of THE PEARL / THE PEARL AKOYA/ THE PEARL SUB is not at a minimum, indicates the status of the network connection: current, successful, failure.

STEREO USE WITH 2 SPEAKERS

Use only one remote control to drive a stereo pair. Do not activate another remote in the same room.

COLOR CODES OF THE STATUS LED

- CYAN** DLNA input: wifi, Ethernet, domestic streaming , internet streaming, AirPlay
- GREEN** Spotify Connect
- WHITE** Aux In Input
- YELLOW** Optical input
- BLUE** Bluetooth input
- RED (flashing)** Connexion to network failed
- PURPLE** Automatic calibration running

WIRED AND NON-WIRED INPUTS THE PEARL / THE PEARL SUB

ANALOG INPUT

This input can be connected to an audio source (CD player, MP3 player, smartphone, TV) equipped with an analog output RCA or mini-jack type. Use RCA / RCA cord or minijack / RCA cord (not included)

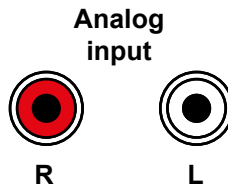

USB INPUT

This input is only useful for use in Wi-Fi / Ethernet mode (paragraphs 4,5,6 below). Connect a USB stick or hard drive containing audio files to this input to automatically network them. All files in formats recognized by the DLNA server included in THE PEARL are then listed in the Stream Audio Control application and can be read by all Cabasse Stream players connected to the same network. The PEARL USB socket has a 5V - 1A DC power supply for use with a portable hard drive without external power supply.

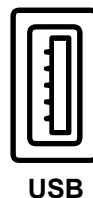

WIRED AND NON-WIRED INPUTS THE PEARL AKOYA

ANALOG INPUT

This input can be connected to an audio source (CD player, MP3 player, smartphone, TV) equipped with an analog output RCA or mini-jack type. Use the included RCA / mini-jack adapter for RCA-RCA cord or minijack / RCA cord (not included), or a mini-jack/mini-jack cord if the source output is mini-jack type.

Micro-USB INPUT

This input is only useful for use in Wi-Fi / Ethernet mode (paragraphs 4,5,6 below). Connect a USB stick or hard drive containing audio files to this input to automatically network them. Use the supplied Micro-USB/USB adapter if needed. All files in formats recognized by the DLNA server included in the speaker are then listed in the Stream Audio Control application and can be read by all Cabasse Stream players connected to the same network. The speaker micro-USB socket has a 5V - 1A DC power supply for use with a portable hard drive without external power supply.

BLUETOOTH CONNECTION

1. Once the speaker is on, press the "Pairing" button on the back
2. The "Pairing" LED on the back should flash
3. Activate Bluetooth on your mobile
4. Select "THE PEARL XXXX Cabasse" from the list of available devices



WIRE CONNECTION (LAN) TO THE ETHERNET NETWORK

The wired Ethernet connection guarantees an optimum and constant transfer rate in any environment. Use this if Wi-Fi mode operation shows untimely cuts or stops of music, signs of a saturated Wi-Fi network, or too much router-to-stream distance.

Connect an RJ45 cable between the speaker and your router (or Box Internet).

The connection is established when the ETH diode changes to solid blue. The WIFI connection is then automatically disabled.

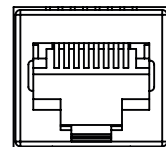

Ethernet

CAUTION: DHCP mode of the router must be enabled.



WARNING!

An update of software can start automatically as soon as an internet connection is made.

The beginning and the end of the update are announced by voice.

***Do not turn off or disconnect
your speaker
during updates that may
require several minutes.***

WIRELESS DLNA CONNECTION (WLAN) TO WIFI NETWORK WITH THE CABASSE STREAM CONTROL APPLICATION



1. Install the Cabasse Stream CONTROL App on your tablet / smartphone from "Play Store" for an Android device, or "App Store" for an Apple product.
2. Open the "settings" or "parameters" App of your smart phone or tablet, select "Wi-Fi " then "THE PEARL XXX" among the list of available networks. You might have to wait a little for the speaker to be listed.
3. Open the application and choose "configure this new player"
4. Follow the instructions and upon request select the wi-fi network to be used and enter the network password.
5. Start listening to your favorite music from your smartphone, key or hard drive connected to THE device's USB input, or using sources connected to its analog input or optical input.

The sources connected to the analog and optical inputs of the device can be played by all the other Stream devices belonging to the same zone.

STREAM CONTROL APPLICATION

Open the Cabasse StreamCONTROL application and launch the tutorial to discover the main features of the application.



Naviguez dans l'application

La barre de navigation inférieure vous donne accès aux différentes fonctionnalités de l'application.

Naviguez facilement entre :

- Vos favoris
- Les services de musique
- Vos appareils musicaux et groupes
- Les paramètres généraux

Terminer



Contrôle vocal

Installez le contrôle vocal sur chacun de vos appareils.

Dans l'écran des paramètres, appuyez sur "Contrôle vocal".

Sélectionnez l'appareil sur lequel vous souhaitez l'activer puis suivez les instructions qui vous seront présentées.

Terminer

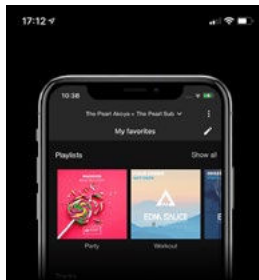

Des favoris centralisés

L'ensemble de vos favoris sont regroupés à un seul endroit de l'application.

Ils sont classés par listes de lecture, musiques et radios.

[Ouvrir les favoris](#)

Terminer



Gérez vos zones de lecture

Appuyez sur le bouton **Group** pour créer ou gérer vos différentes pièces.

Ensuite, regroupez ou séparez les appareils musicaux de votre réseau et sauvegardez cette zone à la volée.

Terminer



Options de lecteur

Appuyez sur **⋮** pour afficher les options disponibles sur les lecteurs de votre zone en cours de lecture :

- Mise en veille
- Changement de source (Wi-Fi, BT, Aux (N, ...))
- Lecture ou enregistrement de 5 presets
- Paramètres de l'appareil

Astuce : glissez à gauche ou à droite pour changer de lecteur.

[Ouvrir les options de l'appareil](#)

Terminer

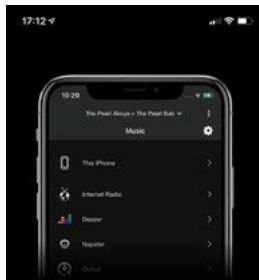

Toute votre musique

Musique locale, services en ligne, morceaux partagés sur le réseau... Tout est à portée de doigt dans cet écran.

Astuce : appuyez sur le bouton de réglages pour choisir quels services seront affichés.

Terminer

17:12

File d'attente

Appuyez sur le bouton  depuis l'écran de lecture pour visualiser et modifier l'ordre des morceaux dans votre file d'attente.

Terminer

17:12

Menu de lecture d'un média

Appuyez sur  d'un média pour afficher ses options de lecture :

- Jouer / Jouer sur...
- Jouer ensuite
- Ajouter à la liste de lecture
- Ajouter aux favoris
- ... et d'autres options selon le média.

Terminer

17:12

Mode stéréo

Le mode stéréo est configurable dans une zone qui contient plusieurs appareils.

Dans l'écran de lecture, appuyez sur le bouton à droite de la barre volume pour afficher les paramètres de volume.

Appuyez sur le bouton à gauche d'un lecteur pour alterner entre Gauche, Droite ou Stéréo.

Terminer

17:11

Sélectionnez votre zone de lecture

Ce bouton indique le(s) appareil(s) musicaux que vous êtes en train de contrôler.

Appuyez dessus pour sélectionner ou configurer une nouvelle zone de lecture.

Astuce: faites un appui long pour l'éditer.

Ouvrir le menu multiroom

Terminer

USE / SYNCHRONIZE WITH A TV SET

THE PEARL / THE PEARL AKOYA / THE PEARL SUB

CONFIGURATION

1- Lay the device next to your TV, or a pair of devices on both sides of the TV on a solid stand.

2- Leave a space of at least 3 centimeters between the rear wall and the appliance.

3- Connect it to the TV with one of the 2 available inputs. Favor the SPDIF coaxial solution:

- SPDIF optical input: Connect the "OPTICAL IN" input to the TV audio output (TV Audio OUT) with the supplied optical cable or equivalent. Make sure that the protective caps at the ends of the optical cable are removed.

- The device analog RCA input: if the TV does not have an SPDIF optical output, connect the "AUX IN" input to the TV's analogue stereo output (RCA TV Audio out) with an RCA-RCA cable , or to the headphone output of the TV with a Jack-RCA cord (not supplied).

- THE PEARL AKOYA analog 3.5mm jack input: if the TV does not have an SPDIF optical output, connect the "AUX IN" input to the TV's analogue stereo output (RCA TV Audio out) with an RCA-RCA cable and the supplied RCA to mini-jack adapter, or to the headphone output of the TV with a Jack-mini-Jack cord (not supplied).

DEACTIVATION OF THE SPEAKERS OF THE TELEVISION

Turn on the TV, open the TV menu, and look for a tab such as Audio, Sound or Speakers. Use the menu function to switch off the TV speakers. This menu item may for example be labeled «Speaker On / Off» for speakers on / off. If this function does not exist, bring the TV sound volume with the TV remote control to the minimum level.

ACTIVATION OF THE OPTICAL OUTPUT OF THE TELEVISION

If there is no sound with an optical connection, set the chosen optical output in the TV menu if necessary.

DEEE MARKING

Treatment of electrical and electronic devices at the end of their life (applicable in the countries of the European Union).



This crossed-out wheeled bin symbol affixed to the product indicates that this product should not be treated with household waste. It must be handed over to a collection point for the treatment of

electrical and electronic equipment at the end of its life. By ensuring that this product is disposed of properly, you will help prevent potential negative consequences for the environment and human health. Recycling materials will help conserve natural resources. For more information about recycling this product, you may contact your municipality, your dump or the store where you purchased the product.

REPLACING THE BATTERY FROM THE REMOTE CONTROL

Turn the remote control over, facing towards the floor. Remove the old battery and replace it with another type CR-2450 coin cell. Dispose of the used battery according to the information below.



WARNING for explosion hazard if battery is incorrectly replaced: use only the same or equivalent battery. Do not expose batteries to excessive heat such as the sun, fire or the like.

Information about batteries and accumulators in the equipment (Applicable in the countries of the European Union).



This crossed-out wheeled bin symbol affixed to a battery or accumulator indicates that the battery or accumulator should not be disposed of as unsorted household waste but should be collected separately from the battery. to make it easier to process and recycle. It must be returned to a collection point for the treatment of used batteries and accumulators. By ensuring that this product is disposed of properly, you will help prevent potential negative consequences for the environment and human health. Recycling materials will help conserve natural resources. For more information about recycling this product, you may contact your municipality, your dump or the store where you purchased the product.

THE PEARL / THE PEARL SUB

Digital inputs	<ul style="list-style-type: none"> - 1 DLNA input: wired with RJ45 plug or Wi-Fi dual band 2x2 802.11a / b / g / n / ac - 1 Bluetooth 4.2 input - 1 S / PDIF optical input - 1 USB 2.0 input 5V=1A
Analog input	RCA stereo
Power supply	100-240 V ~60/50 Hz, 6A
Consumption	1,400 W
Consumption in Eco mode	2.9 W @ 100-240VAC~50/60Hz
Remote control	Bluetooth low energy
Operating temperature	+5°C à +35°C
Storage temperature	-5°C à +40°C
Moisture rate in use	40% to 70%
Network	10/100Mb Ethernet MAC & PHY Wireless LAN 802.11b/g/n WPS 2.0 Security Digital audio player (DMR with DLNA 1.5)
Audio formats Wifi/RJ45	MP3, AAC, WMA, WAV, AIFF, FLAC, ALAC up to 24 bits/ 192 kHz
Voice control	Google
Music services	Qobuz, Deezer, Napster, Spotify Tidal, Vtuner

Speakers Active 3-way amplification Distortion rate plus noise (THD + N on the tape 20-20 000 Hz for a power of 100 mW and more)	1 coaxial medium-high BCI 1 x woofer 25 HELD tweeter: 300 W medium 300 W woofer 1 000 W Wifi : < 0.2% Bluetooth : < 0.2% Analogic : < 0.2% Optical < 0.2%
Dimensions (h x l x p)	326 x 327 x 323 mm
Weight	18 kg

FUNCTIONS

	Bluetooth connection	WIFI/ETHER-NET via routeur internet / box internet
Loss less audio broadcast		YES
Access to all audio media from the WIFI network (computer ...)		YES
Multi-room		YES
Broadcast smartphone / tablet audio content	YES	YES
Broadcast audio application (youtube ...) from smartphone / tablet	YES	
Broadcasting from USB media		YES
Internet radio and music services		Qobuz, Deezer, Napster, Spotify, Tidal, Vtuner

THE PEARL AKOYA / THE PEARL KESHI

Digital inputs	<ul style="list-style-type: none"> - 1 DLNA input: wired with RJ45 plug or Wi-Fi dual band 2x2 802.11a / b / g / n / ac - 1 Bluetooth 4.2 input - 1 S / PDIF optical input - 1 USB 2.0 input 5V=1A
Analog input	JACK 3,5 mm stéréo
Power supply	100-240 V ~60/50 Hz, 6A
Consumption	1,400 W
Consumption in Eco mode	1,9 -W @ 100-240VAC~50/60Hz
Remote control	Bluetooth low energy
Operating temperature	+5°C à +35°C
Storage temperature	-5°C à +40°C
Moisture rate in use	40% to 70%
Network	10/100Mb Ethernet MAC & PHY Wireless LAN 802.11b/g/n WPS 2.0 Security Digital audio player (DMR with DLNA 1.5)
Audio formats Wifi/RJ45	MP3, AAC, WMA, WAV, AIFF, FLAC, ALAC up to 24 bits/ 192 kHz
Voice control	Google
Music services	Qobuz, Deezer, Napster, Spotify Tidal, Vtuner

Speakers Active 3-way amplification Distortion rate plus noise (THD + N on the tape 20-20 000 Hz for a power of 100 mW and more)	1 coaxial medium-high BCI 1 x woofer 17 HELD tweeter: 300 W medium 300 W woofer 450 W Wifi : < 0.2% Bluetooth : < 0.2% Analogic : < 0.2% Optical < 0.2%
Dimensions (h x l x p)	220 x 220 x 220 mm
Weight	8 kg

FUNCTIONS

	Bluetooth connection	WIFI/ETHER-NET via routeur internet / box internet
Loss less audio broadcast		YES
Access to all audio media from the WIFI network (computer ...)		YES
Multi-room		YES
Broadcast smartphone / tablet audio content	YES	YES
Broadcast audio application (youtube ...) from smartphone / tablet	YES	
Broadcasting from USB media		YES
Internet radio and music services		Qobuz, Deezer, Napster, Spotify, Tidal, Vtuner

THE PEARL PELEGRINA

Digital inputs	<ul style="list-style-type: none"> - 1 DLNA input: wired with RJ45 plug or Wi-Fi dual band 2x2 802.11a / b / g / n / ac - 1 Bluetooth 4.2 input - 1 S / PDIF optical input - 1 USB 2.0 input 5V=1A
Analog input	JACK 3.5mm stereo
Power supply	100-240 V ~60/50 Hz, 6A
Consumption	1,400 W
Consumption in Eco mode	1.9 W @ 100-240VAC~50/60Hz
Remote control	Bluetooth low energy
Operating temperature	+5°C à +35°C
Storage temperature	-5°C à +40°C
Moisture rate in use	40% to 70%
Network	10/100Mb Ethernet MAC & PHY Wireless LAN 802.11b/g/n WPS 2.0 Security Digital audio player (DMR with DLNA 1.5)
Audio formats Wifi/RJ45	MP3, AAC, WMA, WAV, AIFF, FLAC, ALAC up to 24 bits/ 192 kHz ogg, vorbis, dsd 64/128, wmalossless via USB or NAS
Voice control	Google
Music services	Qobuz, Deezer, Napster, Spotify Tidal, Vtuner

<p>Speakers</p> <p>Active 3-way amplification</p> <p>Distortion rate plus noise (THD + N on the tape 20-20 000 Hz for a power of 100 mW and more)</p>	<p>1 medium tweeter TCA 1 x woofer 30 HELD tweeter: 300 W medium 300 W woofer 1 850 W Wifi : < 0.2% Bluetooth : < 0.2% Analogic : < 0.2% Optical < 0.2%</p>
<p>Dimensions (h x l x p)</p>	<p>480 x 480 x 1284 mm</p>
<p>Weight</p>	<p>50 kg</p>

FCC STATEMENT

This equipment has been tested and found to comply with the limits for a Class B digital device, pursuant to Part 15 of the FCC Rules. These limits are designed to provide reasonable protection against harmful interference in a residential installation. This equipment generates uses and can radiate radio frequency energy and, if not installed and used in accordance with the instructions, may cause harmful interference to radio communications. However, there is no guarantee that interference will not occur in a particular installation. If this equipment does cause harmful interference to radio or television reception, which can be determined by turning the equipment off and on, the user is encouraged to try to correct the interference by one or more of the following measures:

- Reorient or relocate the receiving antenna.
- Increase the separation between the equipment and receiver.
- Connect the equipment into an outlet on a circuit different from that to which the receiver is connected.
- Consult the dealer or an experienced radio/TV technician for help.

This device complies with part 15 of the FCC Rules. Operation is subject to the following two conditions : (1) This device may not cause harmful interference, and (2) this device must accept any interference received, including interference that may cause undesired operation.

Changes or modifications not expressly approved by the party responsible for compliance could void the user's authority to operate the equipment. This equipment complies with FCC radiation exposure limits set forth for an uncontrolled environment.

This equipment should be installed and operated with minimum distance 20cm between the radiator & your body

Cabasse



Cabasse SAS - 210, rue René Descartes - BP 10 - 29280 Plouzané - FRANCE
Tel +33 298 05 88 88 - Fax +33 298 05 88 99

www.cabasse.com